

# Sequence Modeling: Recurrent and Recursive Nets

Lecture slides for Chapter 10 of *Deep Learning*

[www.deeplearningbook.org](http://www.deeplearningbook.org)

Ian Goodfellow

2016-09-27

# Classical Dynamical Systems

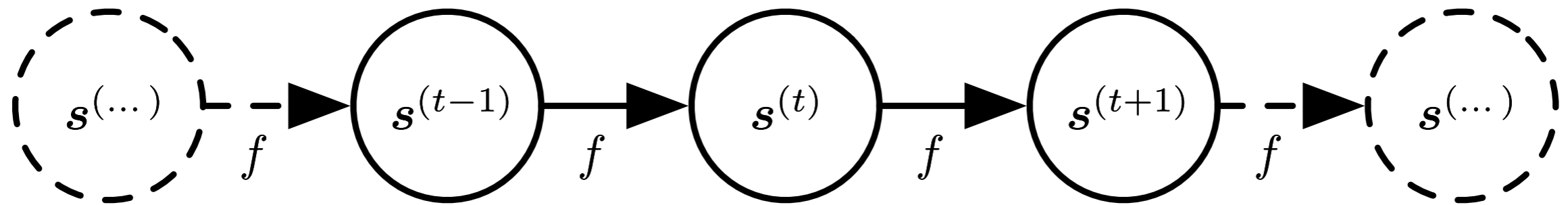

Figure 10.1

# Unfolding Computation Graphs

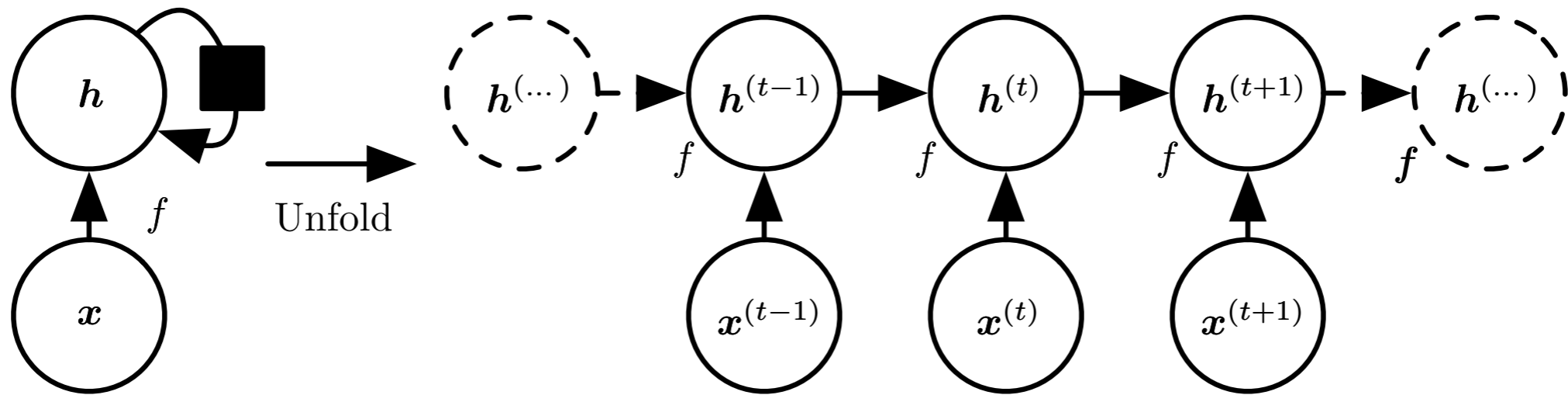

Figure 10.2

# Recurrent Hidden Units

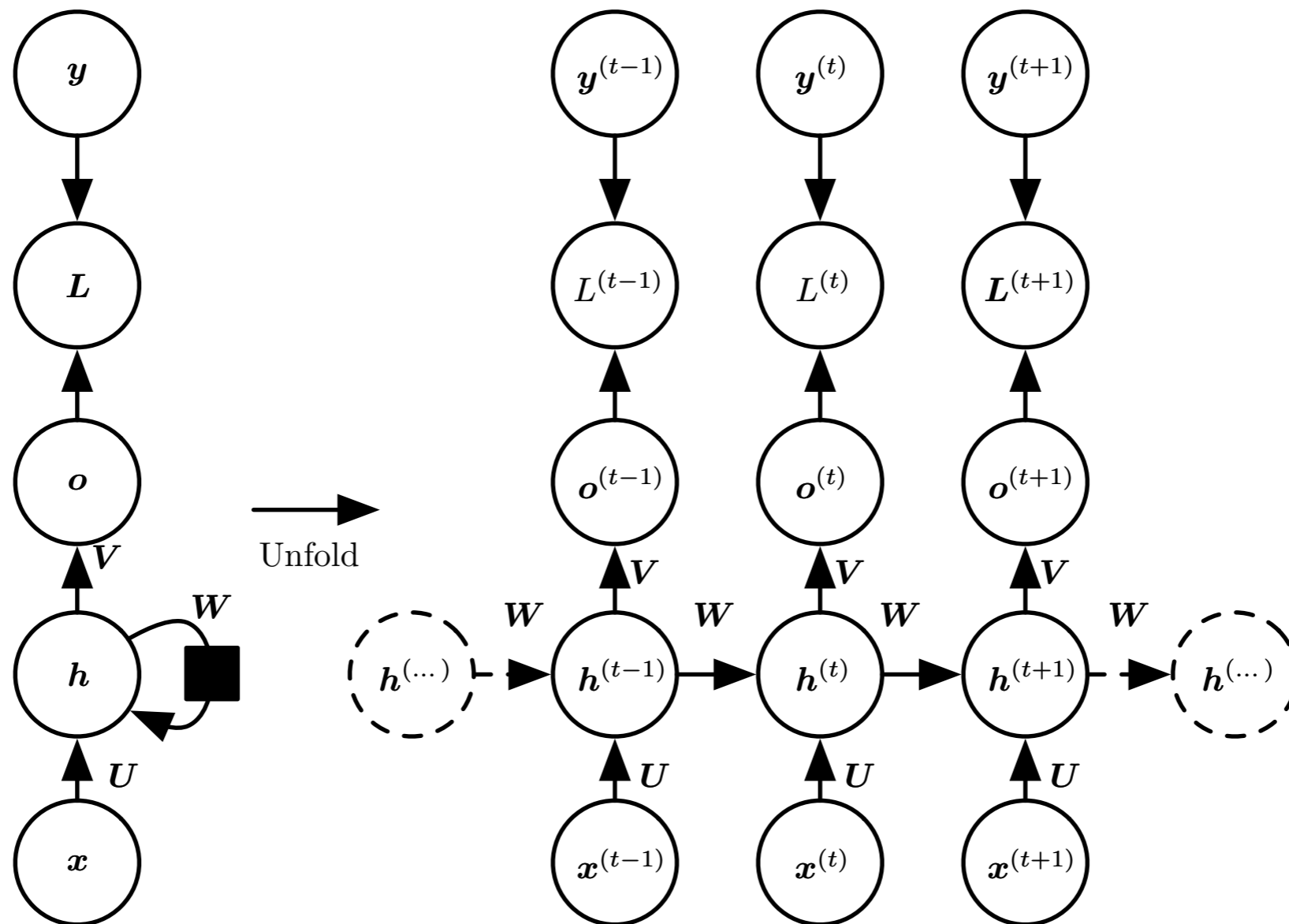

Figure 10.3



# Recurrence through only the Output

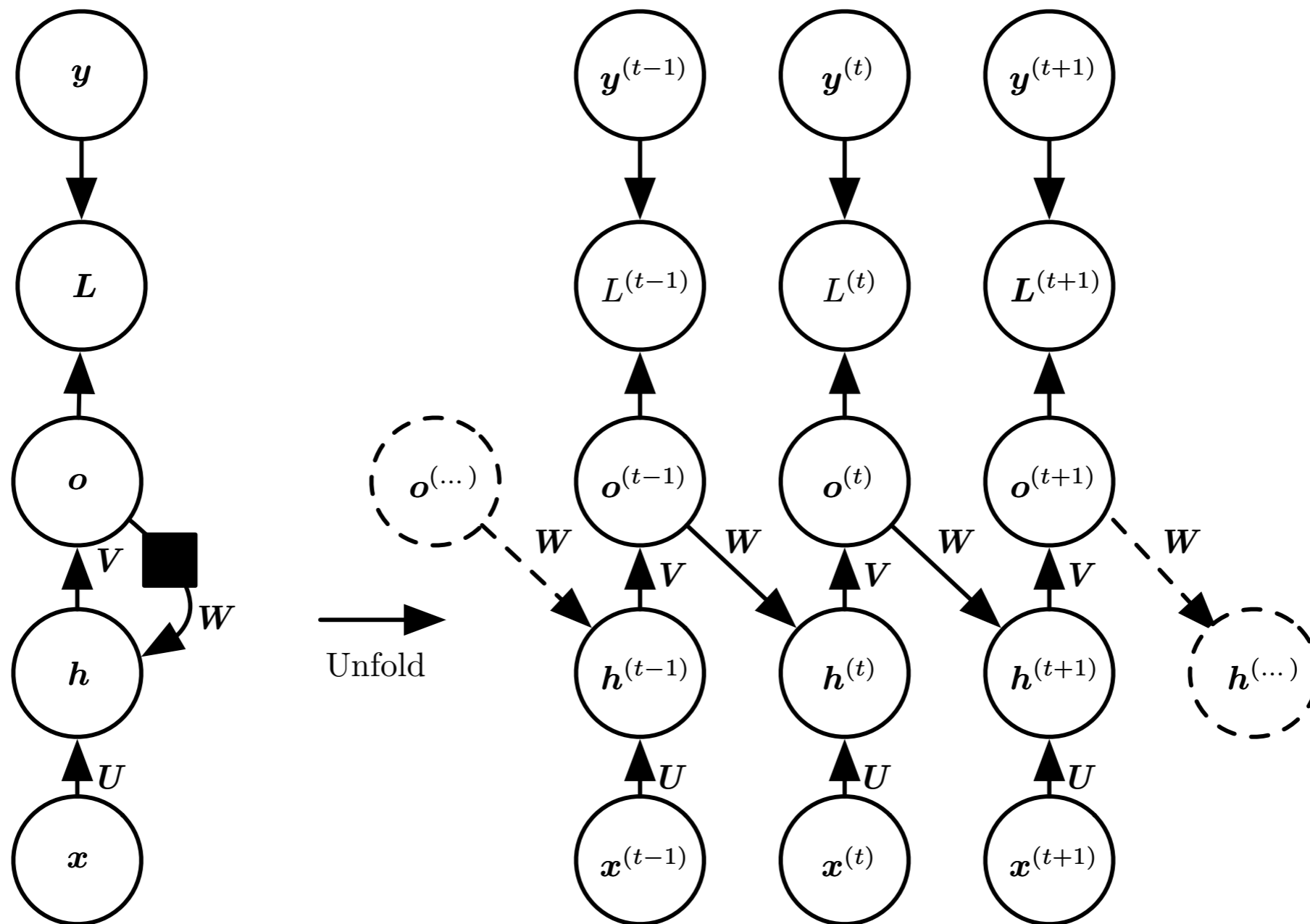

Figure 10.4

# Sequence Input, Single Output

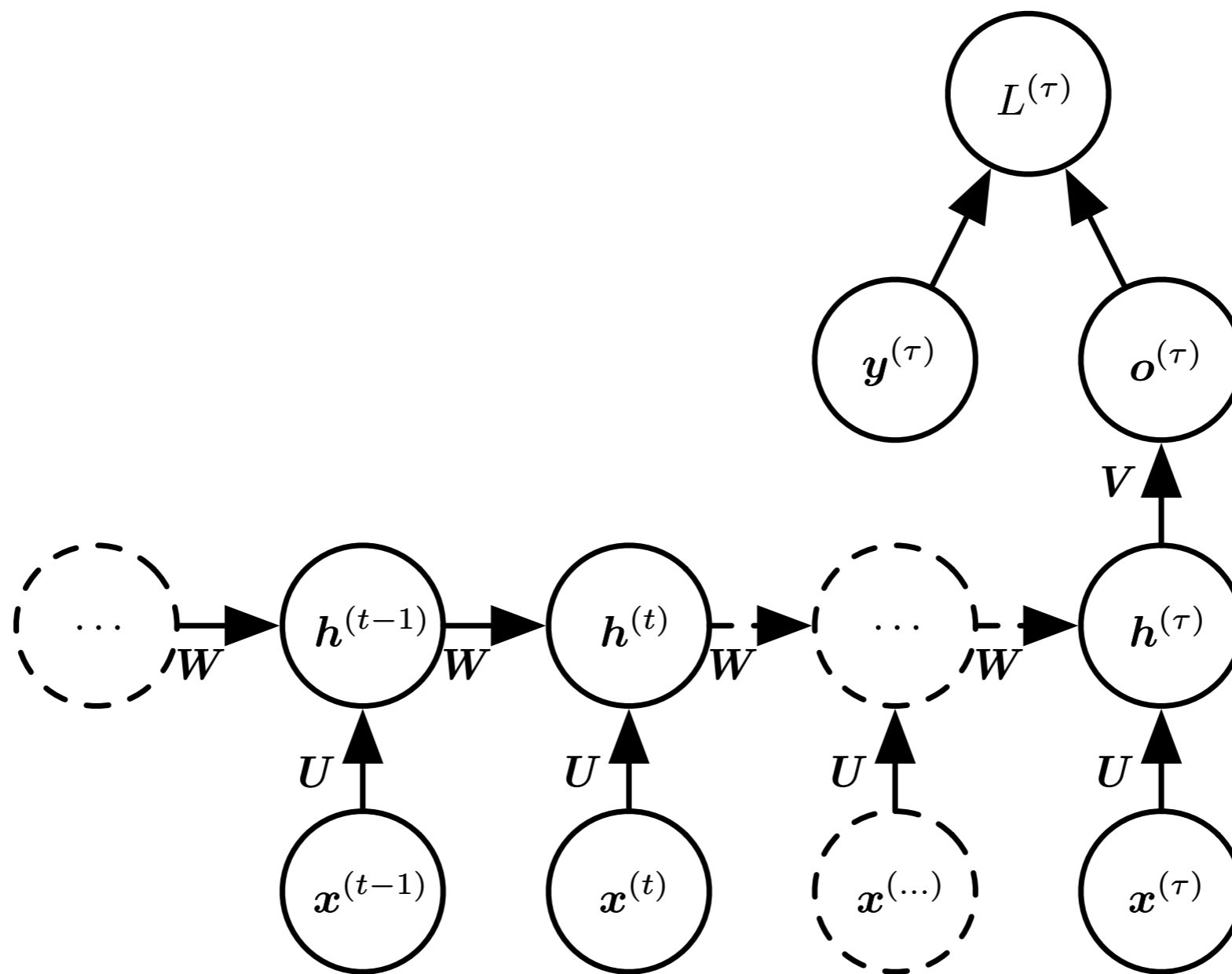

Figure 10.5

# Teacher Forcing

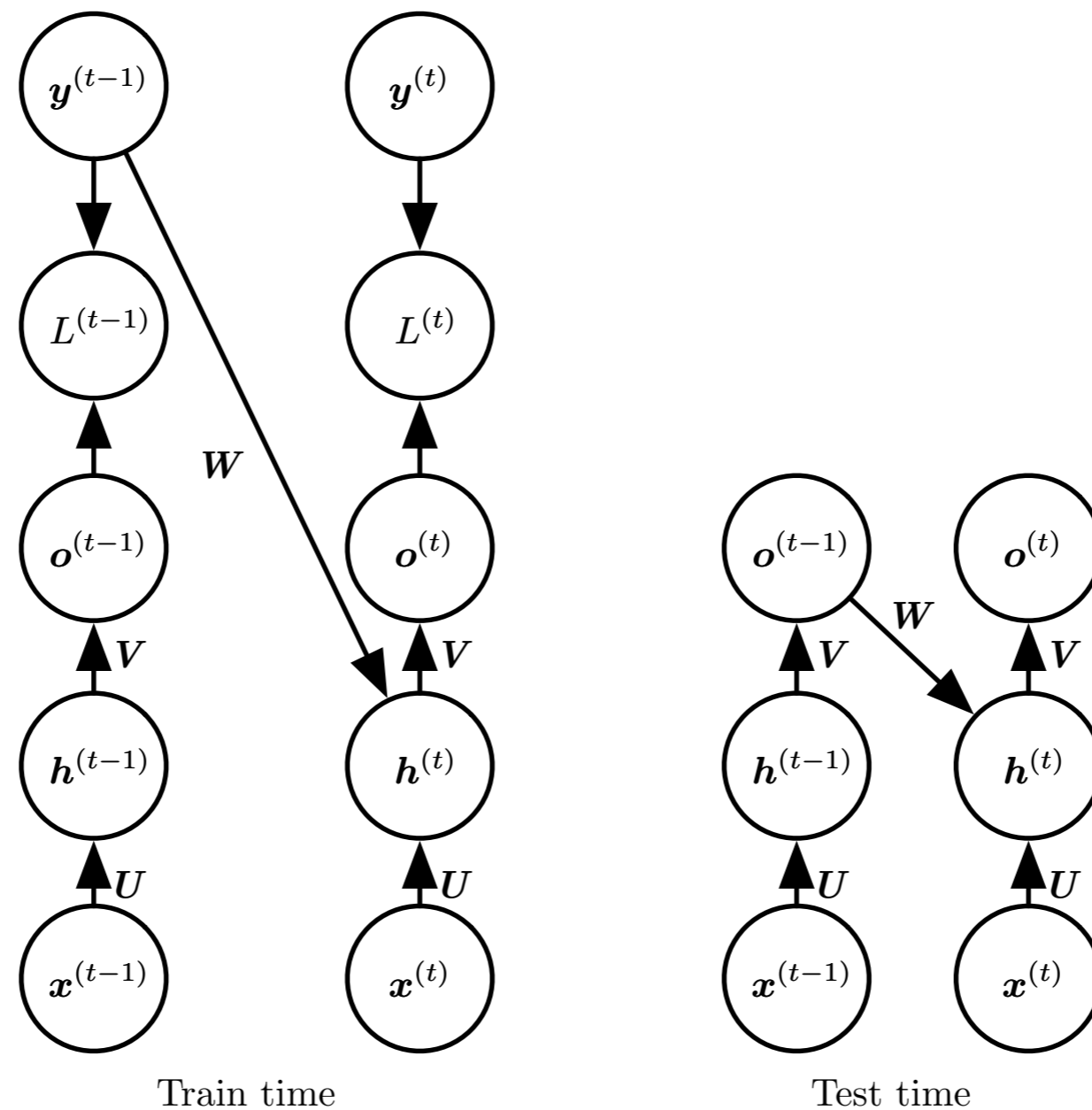

Figure 10.6

# Fully Connected Graphical Model

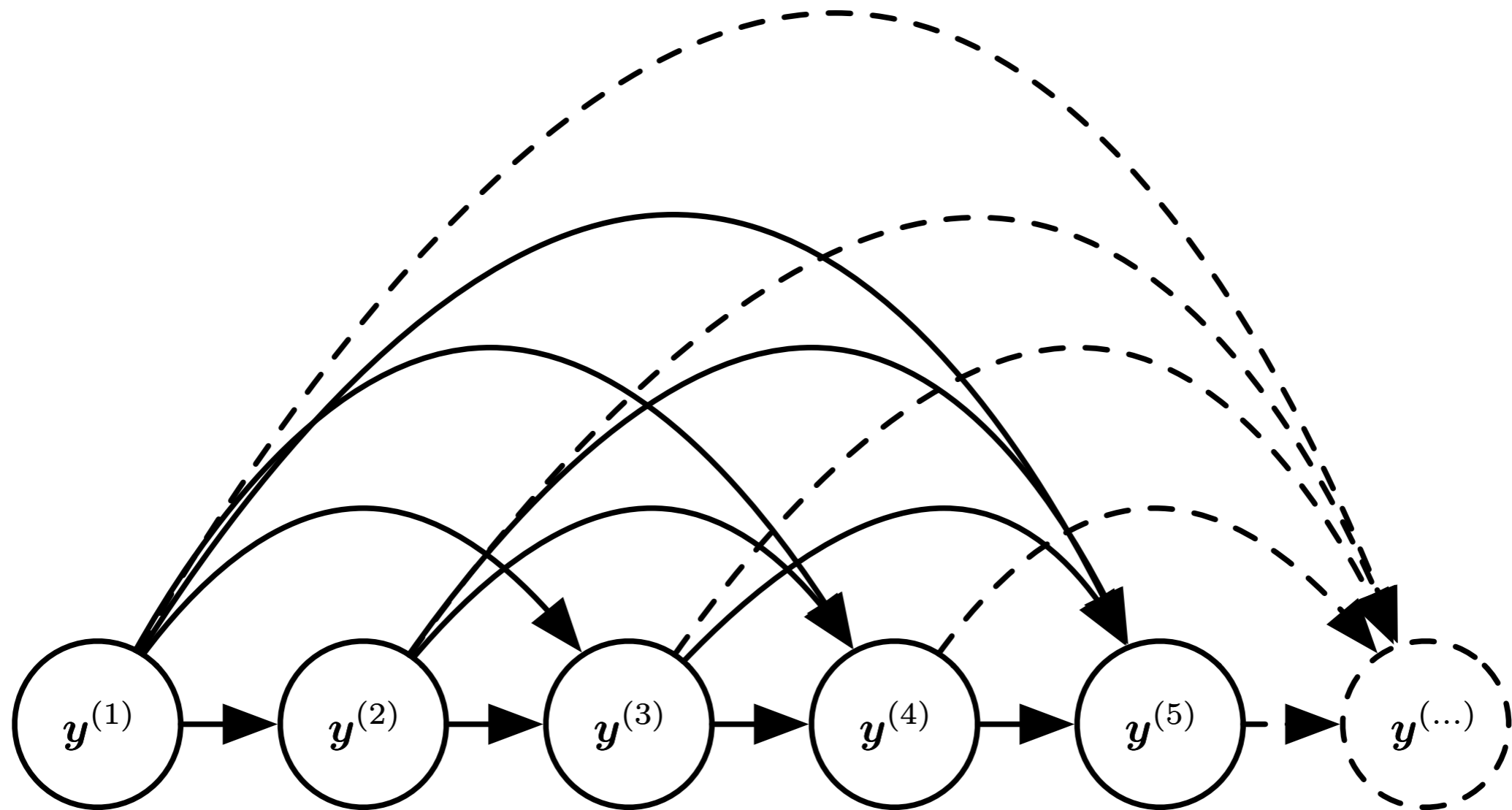

Figure 10.7

# RNN Graphical Model

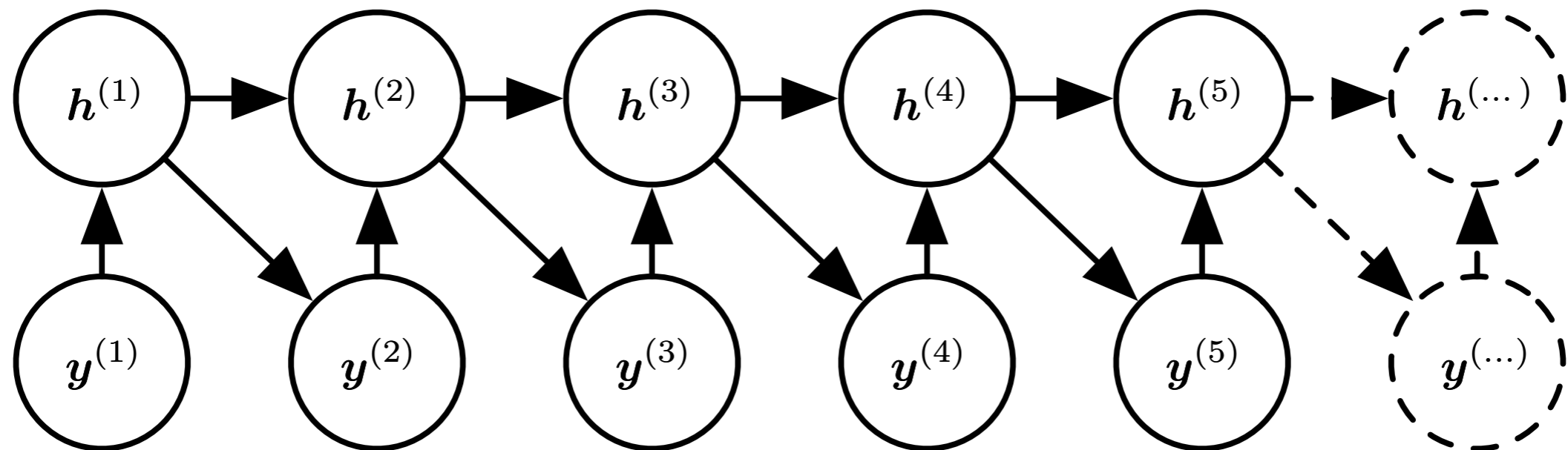

Figure 10.8

(The conditional distributions for the hidden units are deterministic)

# Vector to Sequence

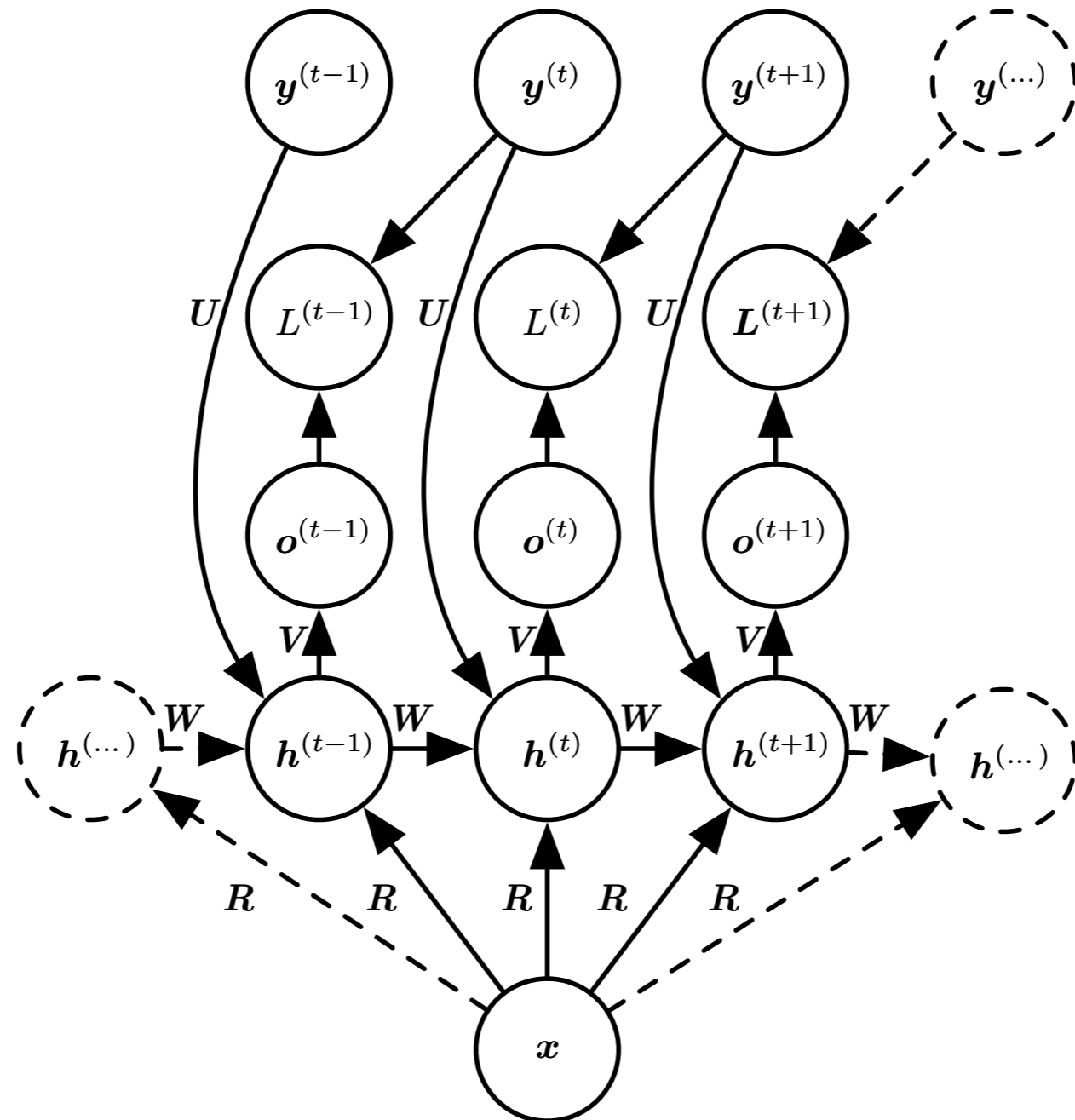

Figure 10.9

# Hidden and Output Recurrence

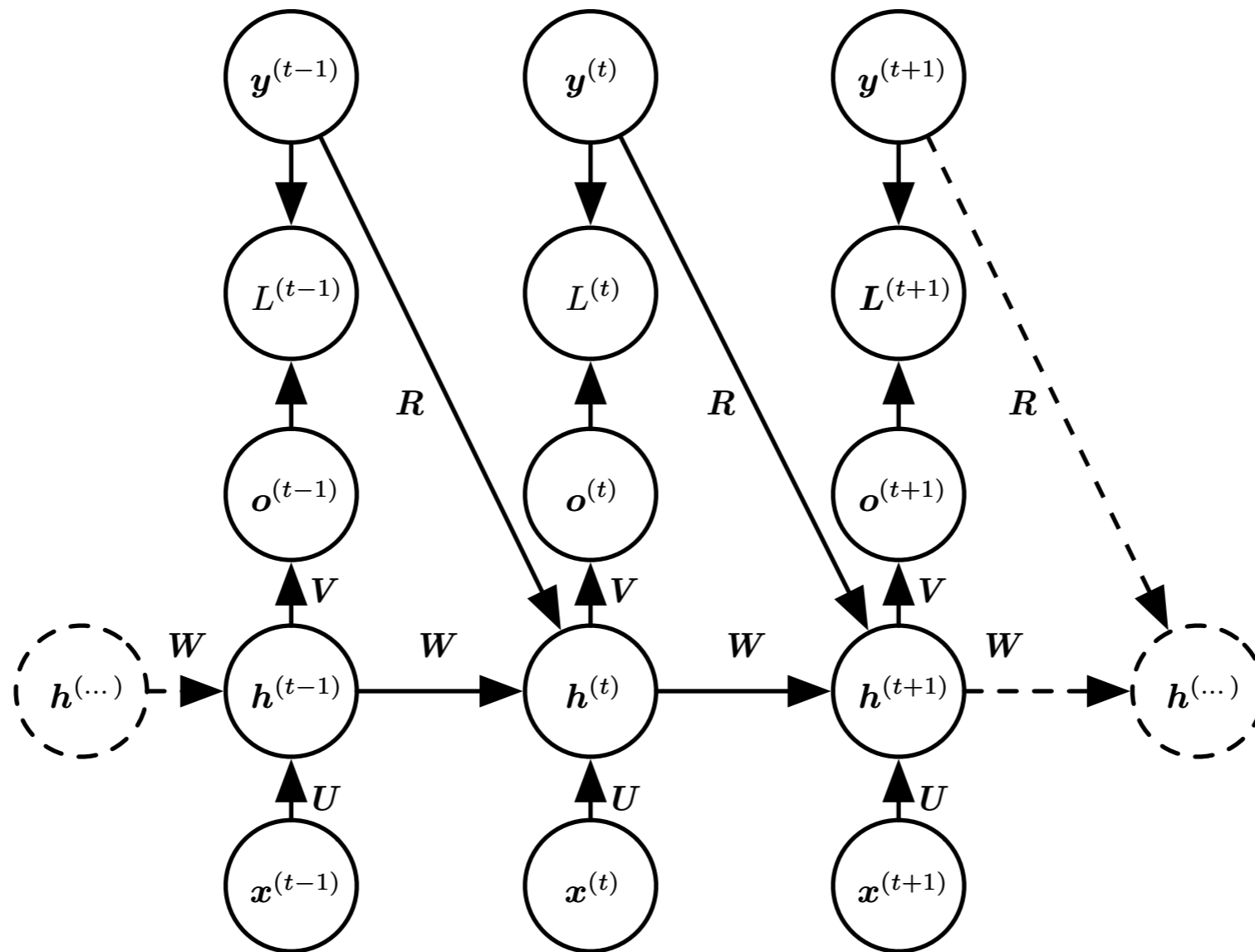

Figure 10.10

The output values are not forced to be conditionally independent in this model.

# Bidirectional RNN

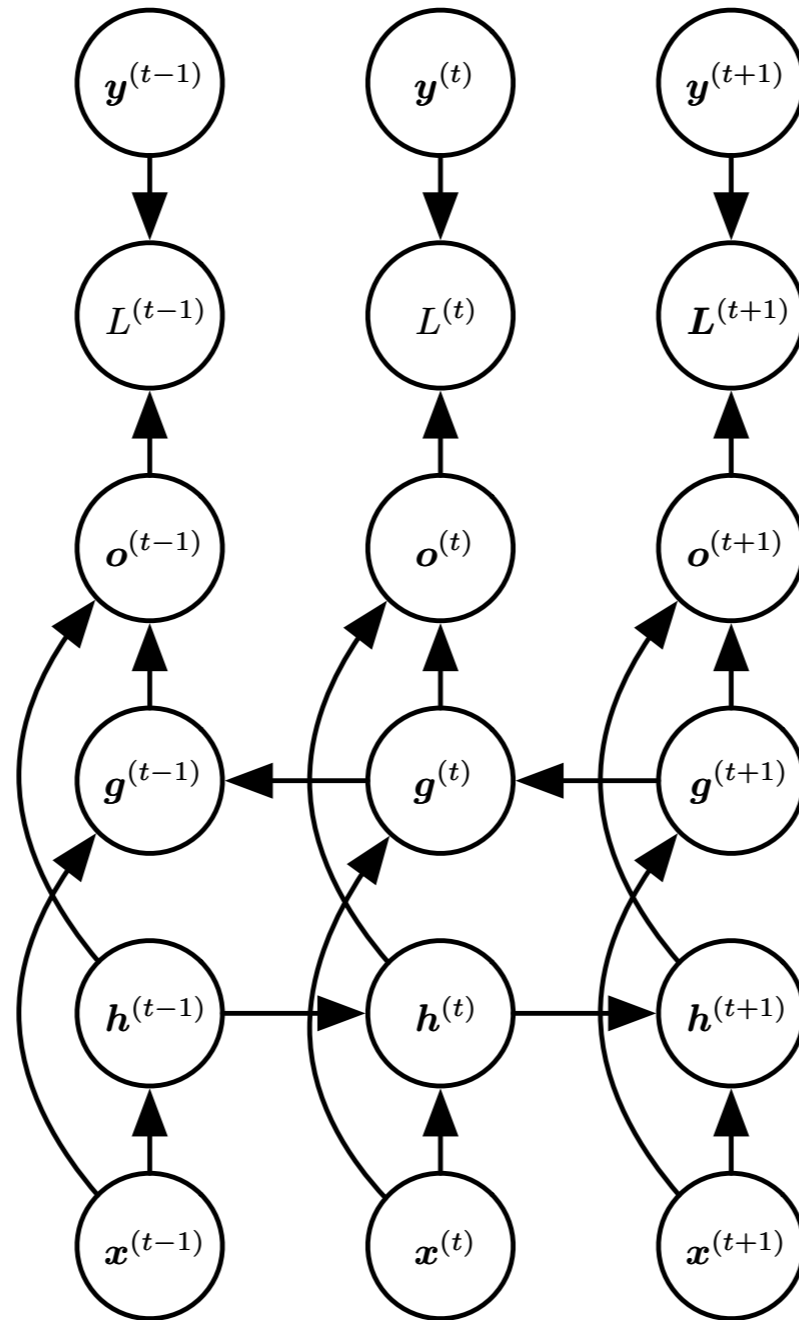

Figure 10.11



# Sequence to Sequence Architecture

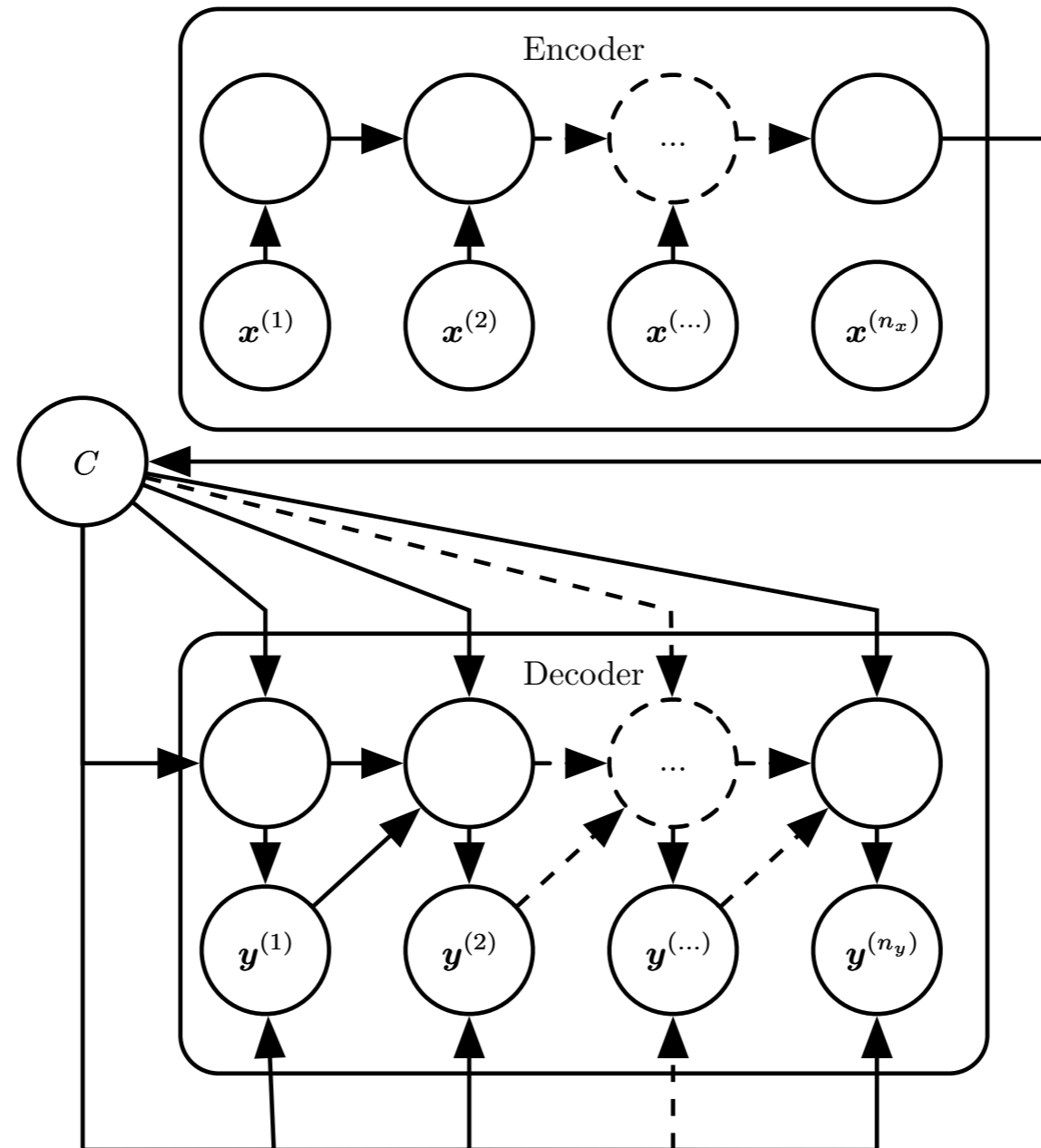

Figure 10.12

# Deep RNNs

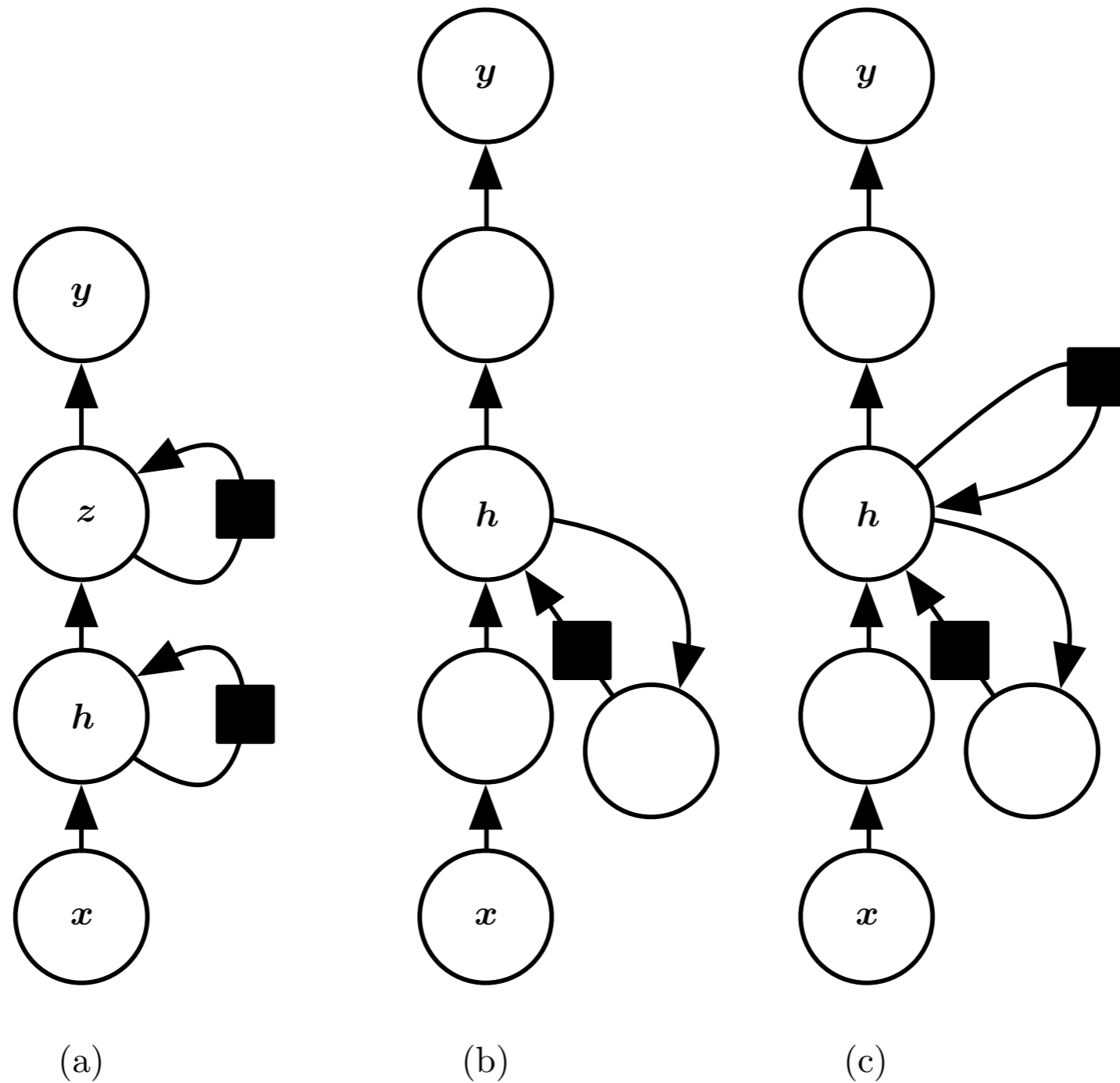

Figure 10.13

# Recursive Network

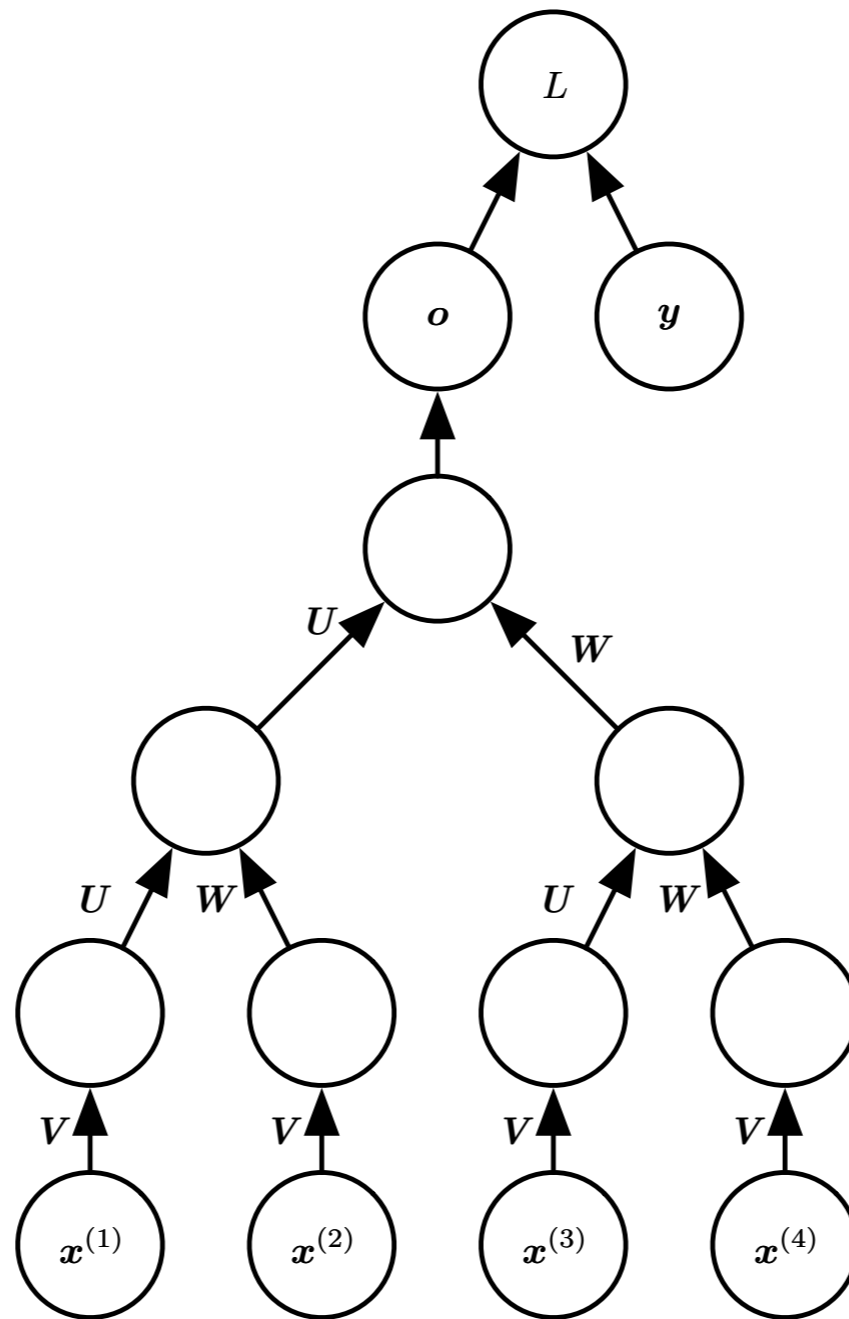

Figure 10.14

# Exploding Gradients from Function Composition

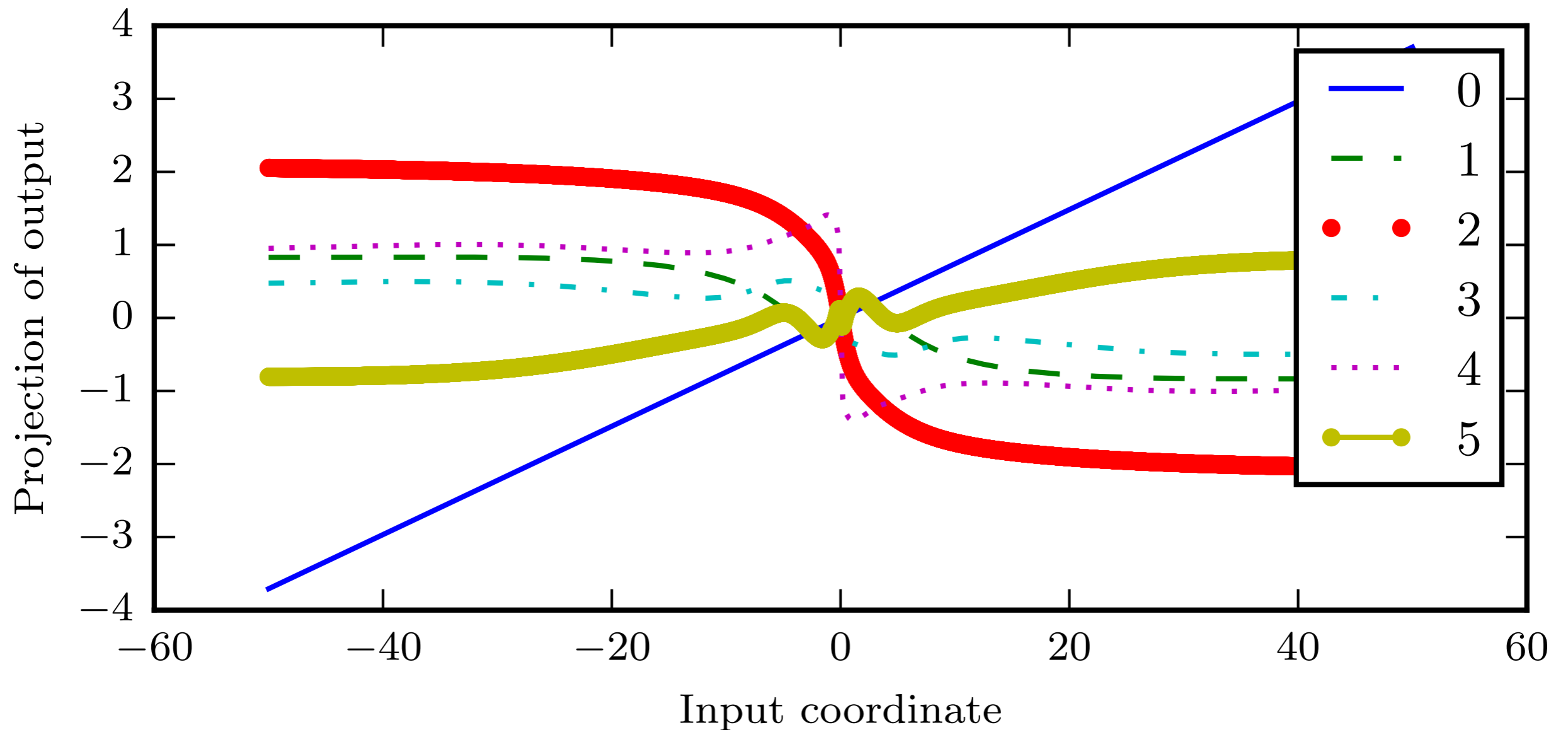

Figure 10.15

# LSTM

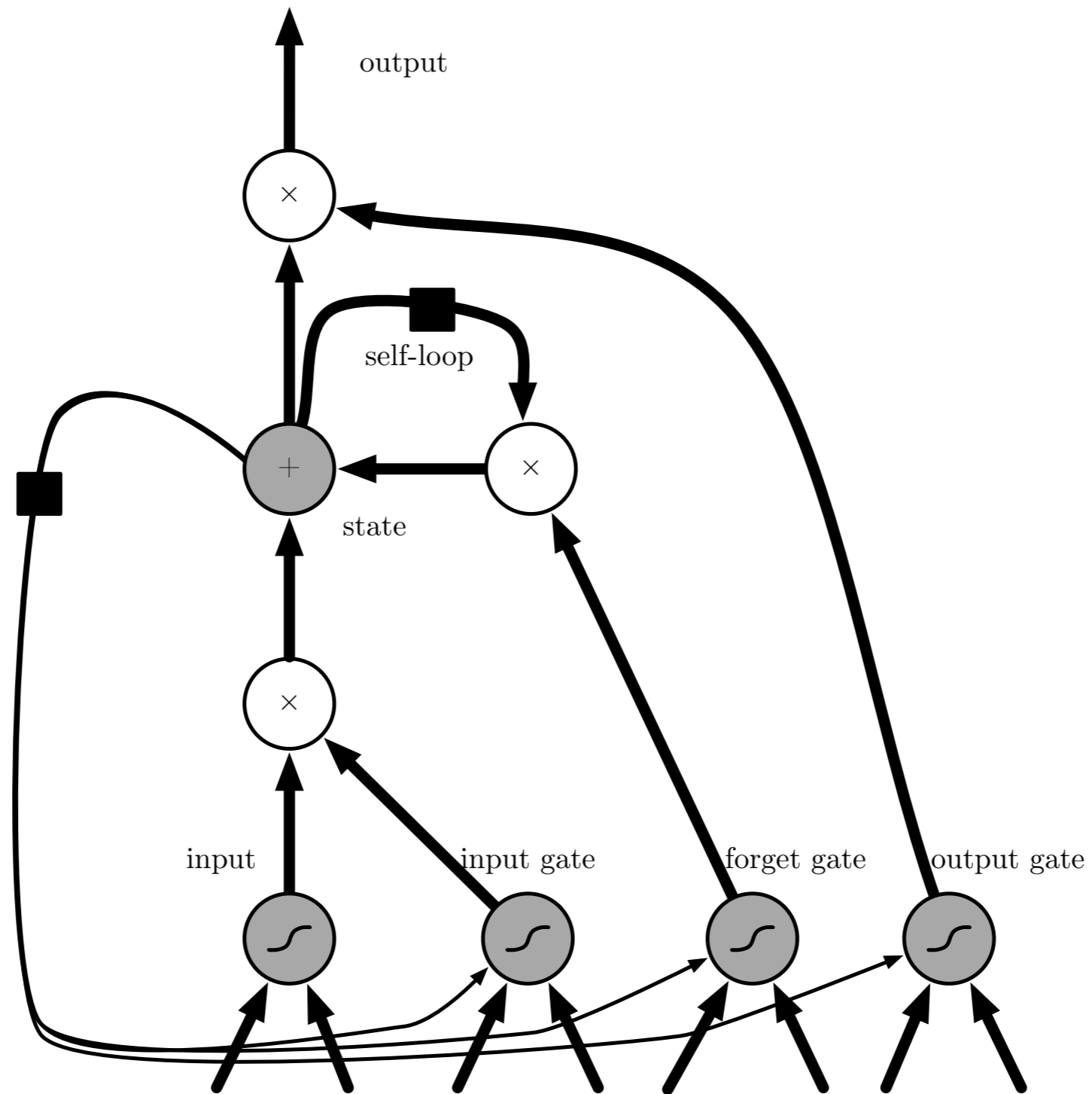
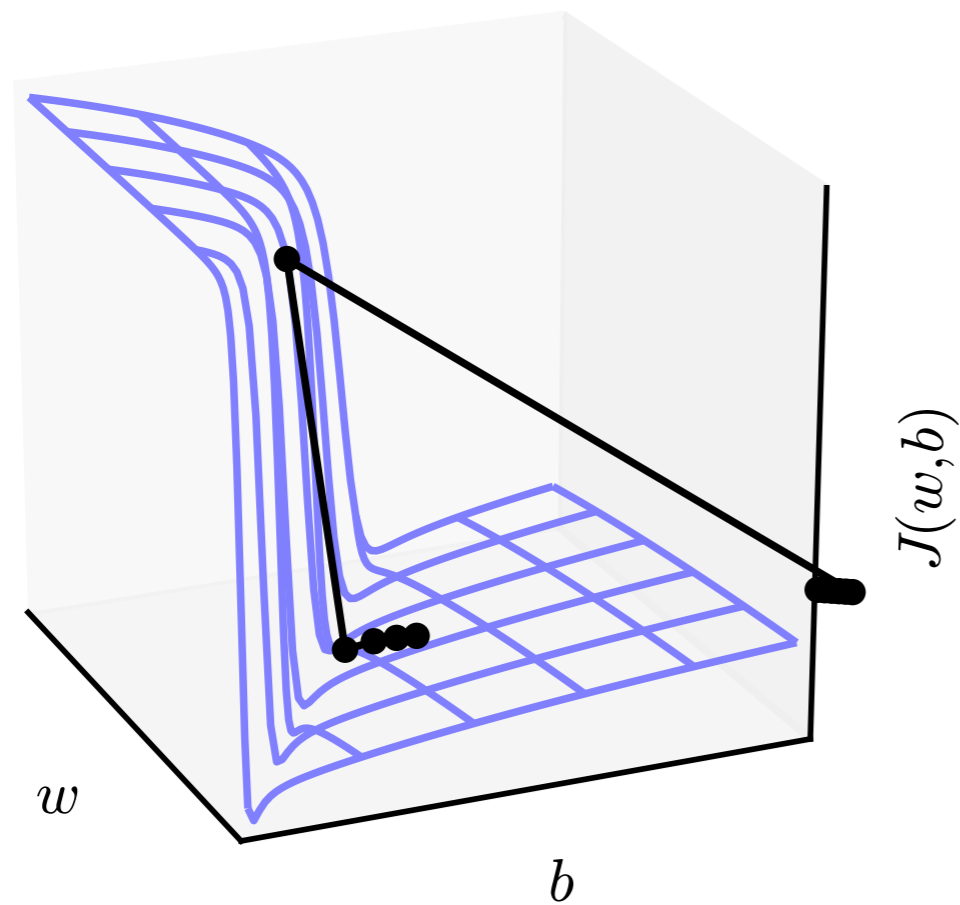

Figure 10.16

# Gradient Clipping

Without clipping



With clipping

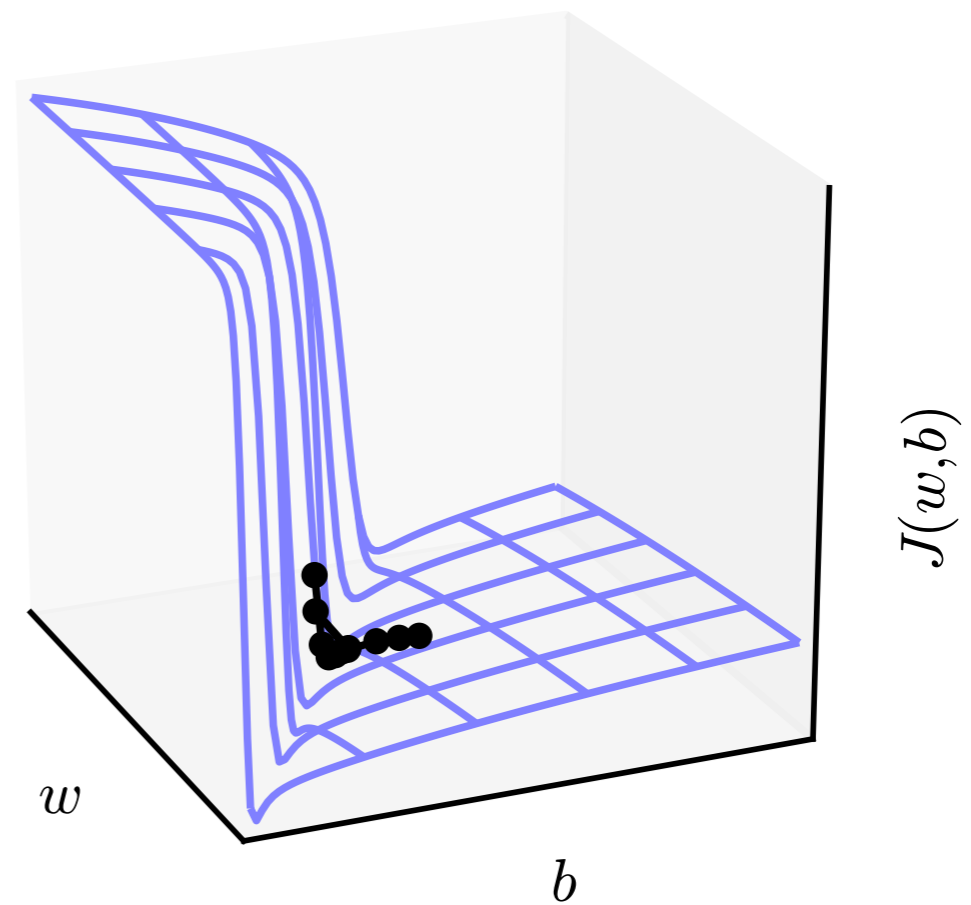

Figure 10.17

# Networks with explicit Memory

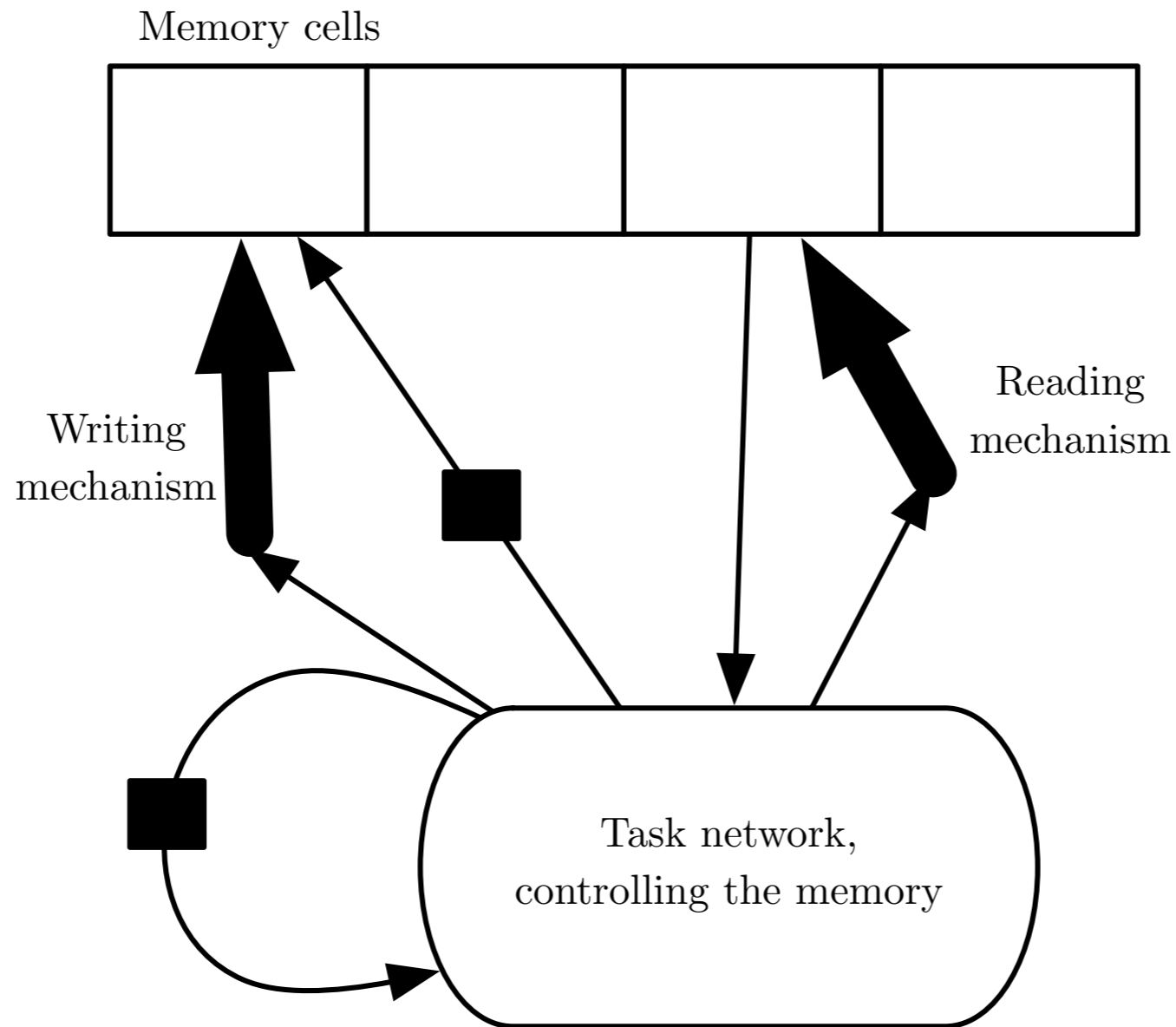

Figure 10.18